

Varenummer: 0107081

Beskrivelse: Seeger låsering AK 68 DIN 983

Mål

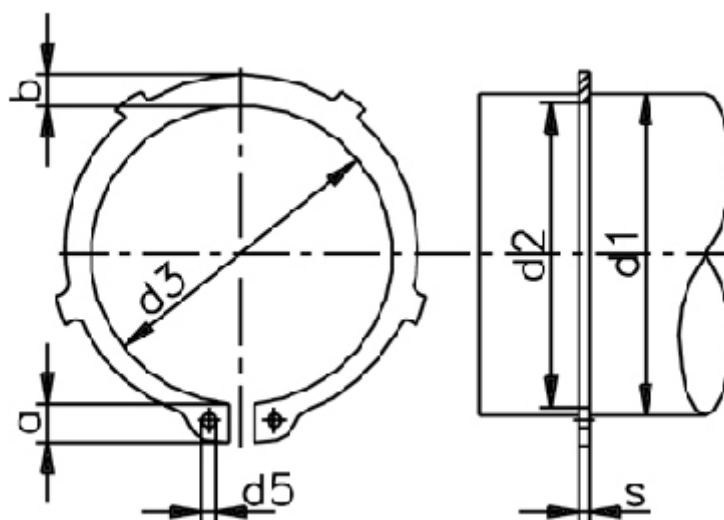

a max	= 10.2	d5 min	= 3.0	Nominal træk	= 4.5
AN mm ²	= 313.0	FN kN	= 52.20	s	= 2.50
Antal takker	= 8	FRg kN	= 23.0	t	= 1.50
b	= 6.5	FR kN	= 135.0	Tang	= ZGA-3
Betegnelse	= AK 68	g	= 2.5	tol	= -0.07
d1	= 68	K kN-mm	= 244.0	tol	= +0,46-1,10
d2	= 65.0	m min	= 2.65	tol	= -0.30
d3	= 63.5	n abl x 1000	= 7	vægt kg/1000	= 23.50